

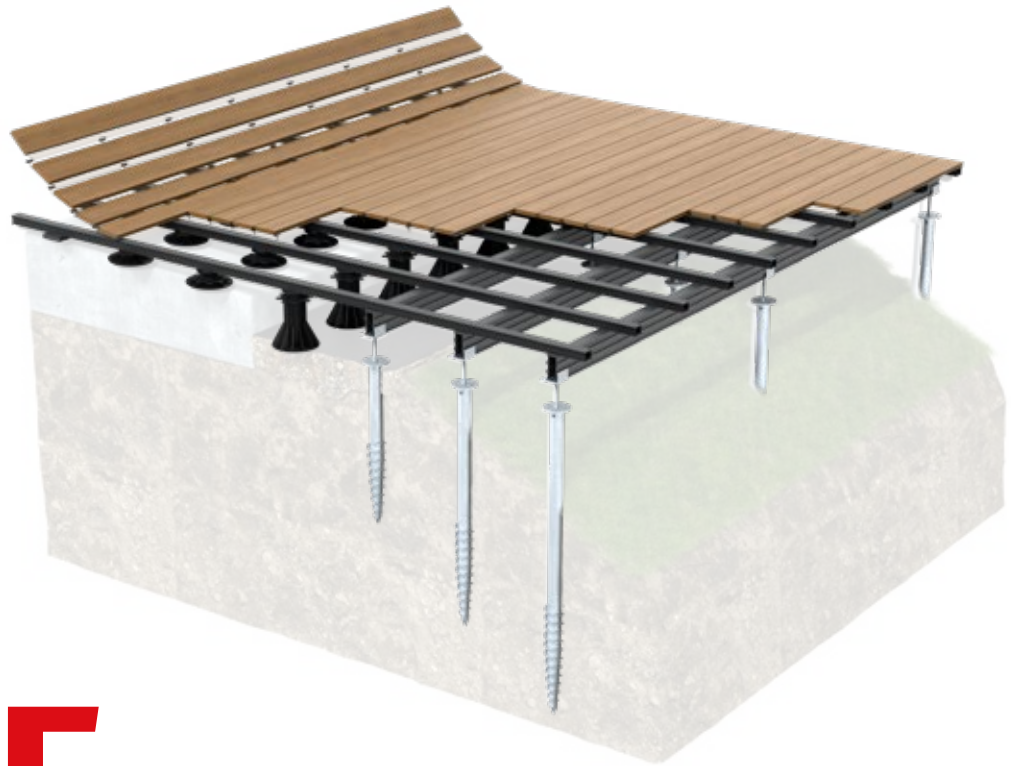

GLOBAL DECKING SYSTEM



CATALOG
2025



THE GLOBAL DECKING SYSTEM



As decking specialists for over 20 years, we are committed to developing sustainable, high-quality solutions. Cobra is the assurance of reliable, tried-and-tested products that create value through innovations combining performance and sustainability.

Right from the design stage, we are committed to use recycled materials, to reduce the packaging and to limit the fossil energy consumption.

Our teams develop unique products such as Hybrid universal clips with their integrated screw, which allow all types of boards to be installed faster, without pre-drilling.

Our aim is to simplify the decking construction and make it more reliable, with solutions such as the STRUCTURAL concept, a complete, versatile and rot-proof aluminum joist system, our NIVO adjustable pedestals, made in France, and the SPIRAL foundation screws, an agile and ecological alternative to concrete.

Fixing, precision, ventilation, stability, drainage...

Cobra helps extend the life of your decking components, so that your deck lasts longer.



STRUCTURES 04

Aluminum joists STRUCTURAL

Pedestals NIVO

Fondation screws SPIRAL

FASTENINGS 18

HYBRID clips

AIR SPACER wedge

COBRA hardware

D-LOCK invisible system

ACCESSORIES 56

BITUDECK tape

GEODECK textile felt

COBRA LINER

COBRA WRENCH

WEDGES

STRUCTURAL STRUCTURES



A DECK FOR LIFE!

The STRUCTURAL® system provides a rot-proof structure that resists moisture, offering unrivalled durability.

These aluminum joists are suitable for all types of environments and conditions.

Unlike wooden structures, aluminum joists are not subject to deformation or weather damages.

STRUCTURAL joists are lightweight, easy-to-handle, high-performance load-bearing elements, perfectly suited to the design of elevated structures on adjustable pedestals or foundation screws.

STRUCTURAL can be laid on any type of soil, whether hard, stabilized, loose or waterproof.

Its modularity means it can be used for a wide range of applications, from composite or wood decking to porcelain stoneware.



STRUC TURAL





LIGHT STABLE DURABLE

- Quick and easy assembly
- Modular and removable
- Excellent mechanical strength
- Precision and consistency - Perfect flatness
- Versatile for decking and paving applications
- Rot-proof - Weatherproof
- Performance that never fades

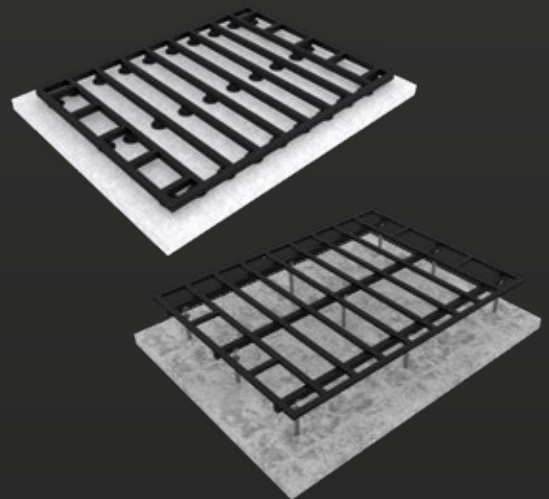

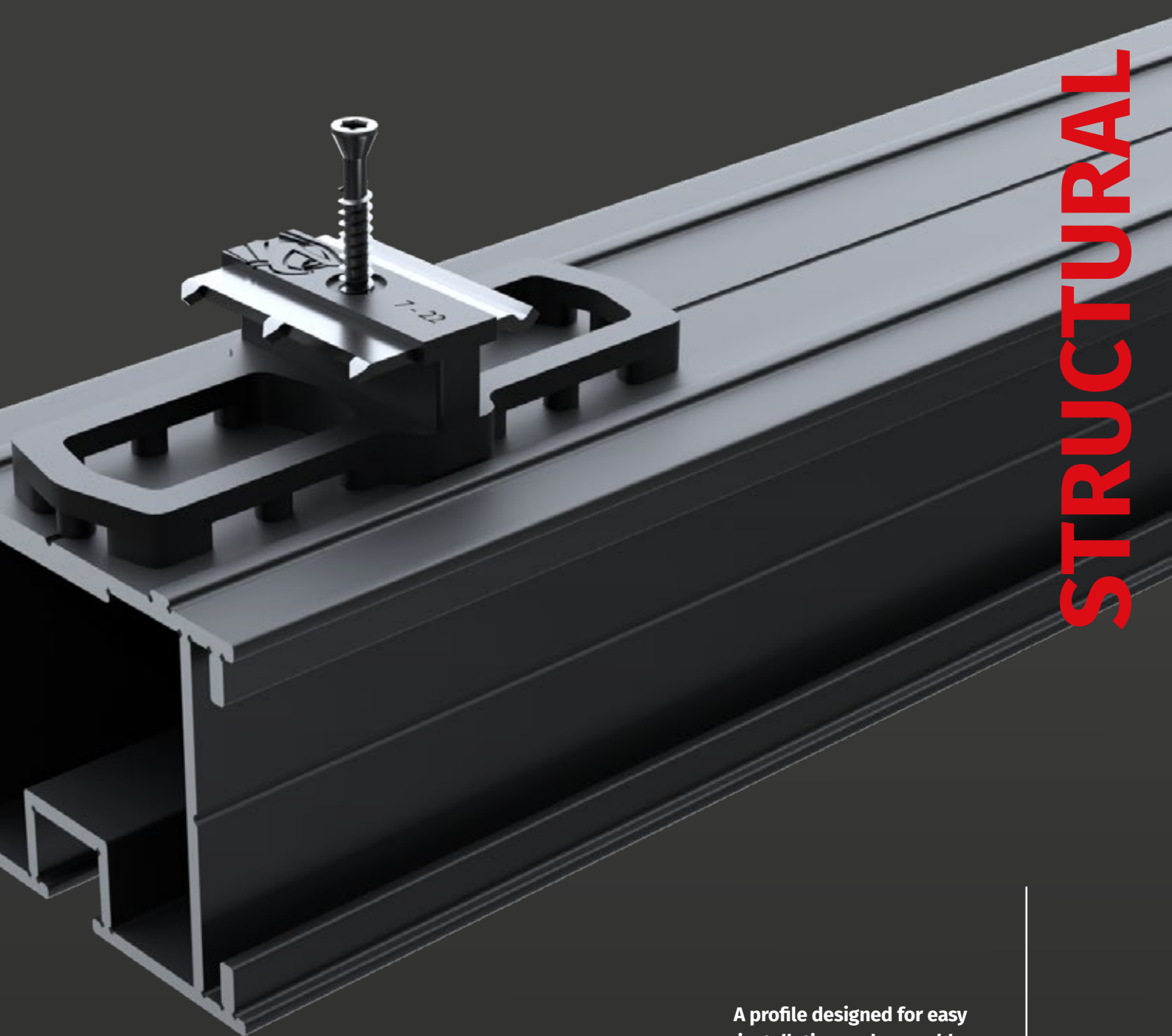

STRUCTURAL

A profile designed for easy installation and assembly.

Perfectly compatible with our Hybrid clips and Nivo pedestals.

My **Deck Planner**
by Felix





JOIST
24X40MM

FD2097



JOIST
40X60MM

FD1892-FD1900

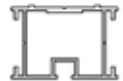

JOIST
80X60MM

FD1893



JOIST
120X60MM

FD1894

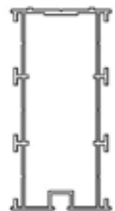



MATERIAL Aluminum alloy EN AW 6063 (TS)

FINISH Black lacquer RAL 9005 Mat
QUALICOAT

USAGE Top side Decking laying
Bottom side Paving laying

STRUCTURAL

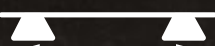
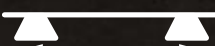
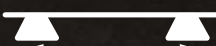

24x40x4000 mm	40x60x4000 mm 40x60x2300 mm	80x60x4000 mm	120x60x4000 mm
3 kg	2,6 kg - 4,6 kg	6,9 kg	9,8 kg
FD2097	FD1892 - FD1900	FD1893	FD1894
0,5M 	1 M 	2 M 	3 M 

STRUCTURAL CONNECTIONS





40X60MM



80X60MM



120X60MM



FD2054



FD1898

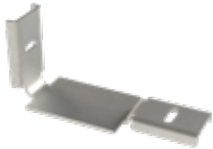
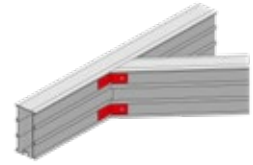
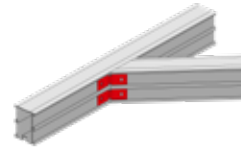
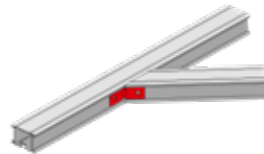

FD2094

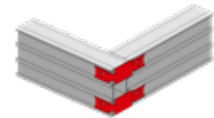
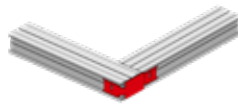

FD1897

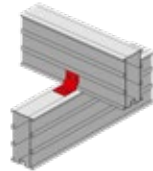
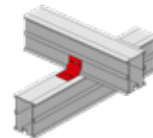
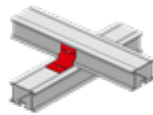

FD1899

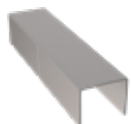
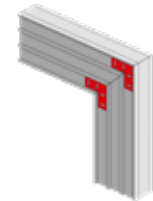

FD1896

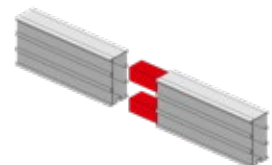
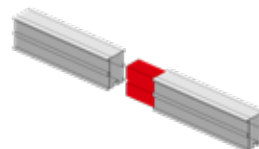
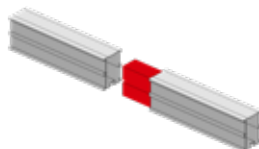

FD1903



Start/End clip
FD2055

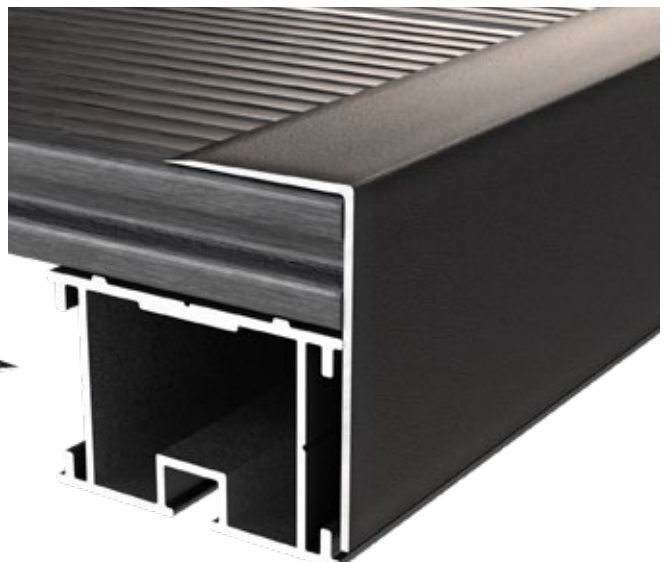

Finishing corner
FD1938



Joist cap
FD2093



STRUCTURAL

FINISHES



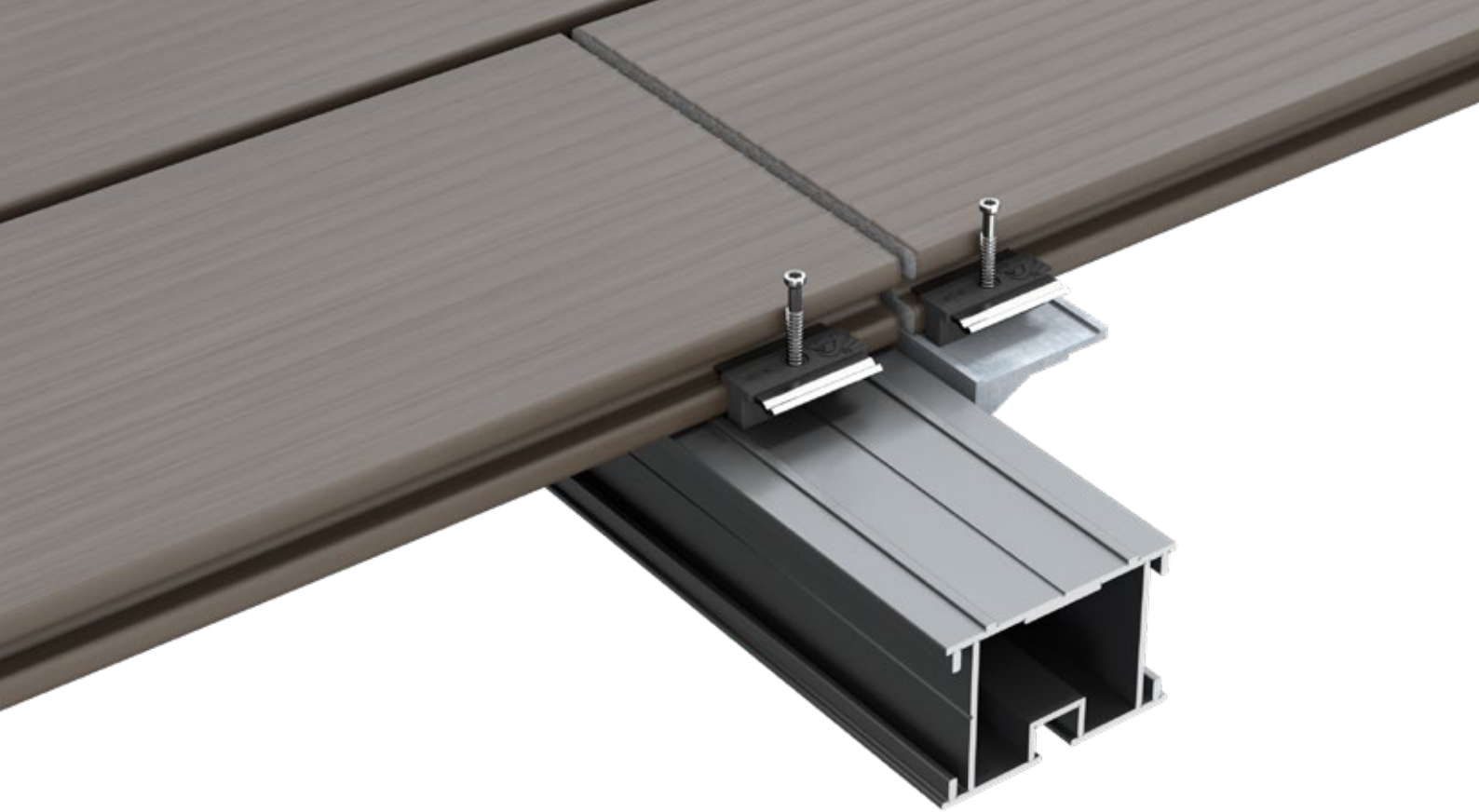

XTEND Structural

This aluminum support enables optimal decking board end-jointing with compliant double fastening, without the need for double joisting.

Easy assembly thanks to its design for convenient screwing.

Supports loads in compliance with the requirements of DTU 43.1 and 51.4

FD1895

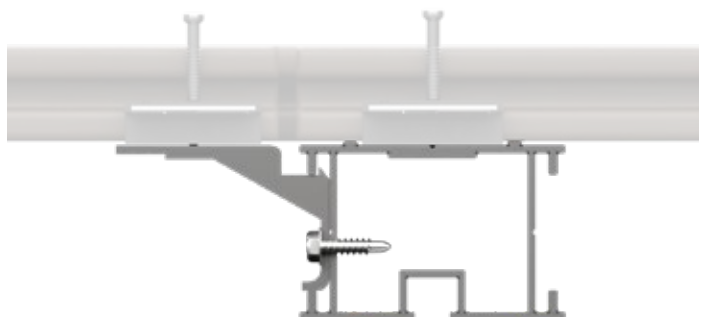

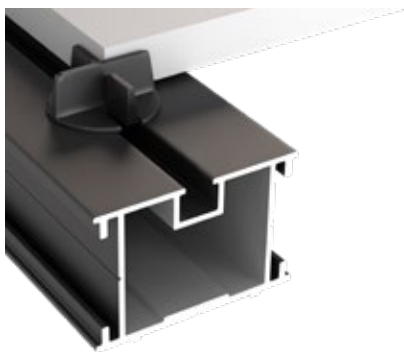

CUT TO SIZE

Available in 2-meters long profiles, Xtend can be cut to optimize its use according to the type of deck joints to be laid and the width of the boards to be butt-jointed.

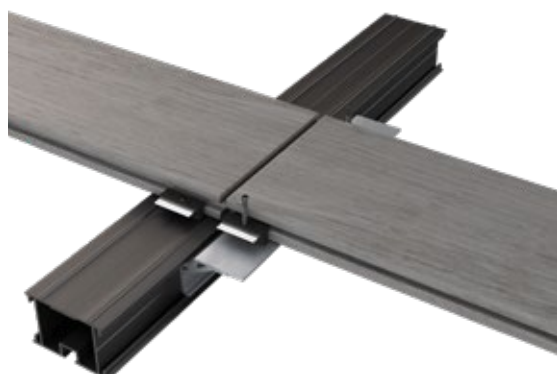

INSTALLATION WITH CLIPS OR SCREWS

Xtend is compatible with the installation of boards with invisible side clips or with top screws suitable for aluminum structures.



PORCELAIN STONEWARE Structural

STRUCTURAL is reversible to provide an IDEAL AND EASY solution for laying porcelain stoneware slabs.

The joist frame provides optimum adjustment and levelling.

Splitable crosspieces (FD0866) are inserted into the groove of the joist and slide out for easy, precise paving.

EPMD bands (FD0939) are easy to apply and provide comfort and cushioning.

This modular, load-bearing system allows multiple geometries and facilitates the creation of finishing elements, such as skirting boards with hooks (FD0864) and the anodized aluminum corner (FD0867).

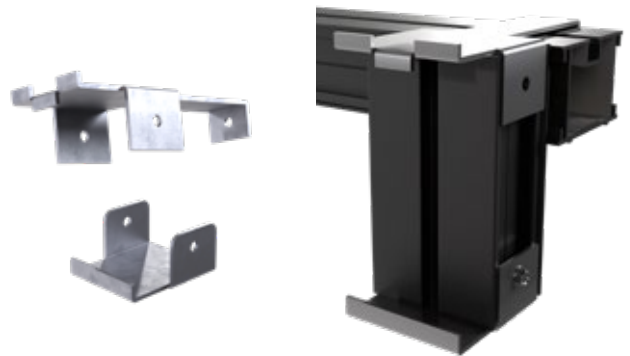

FD0864



FD0867



FD0939



FD0866

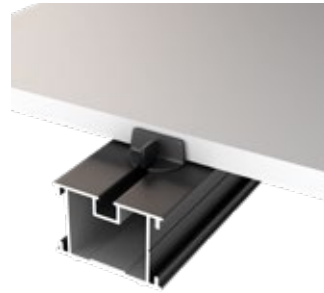
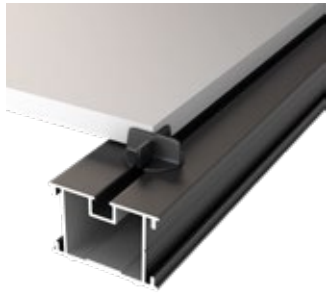

STRUCTURAL

NIVO PLOTS

FIXINGS



AN AGILE, SUSTAINABLE SOLUTION

Whether for decking or paving, adjustable pedestals have become an indispensable solution for outdoor flooring.

Durable products made in France from recycled materials, NIVO pedestals can withstand heavy loads.

They can be used to create a variety of elevations and meet a wide range of installation requirements.

Their advantages are numerous. For example, they eliminate the need for heavy ground work or terrace joints, level the deck with precision, create a useful decking surface without damaging a watertight floor, simplify and hide electrical cables or pipes pass beneath the deck surface, make it easier to replace a slab... They are UV-resistant and withstands climatic variations.

Lightweight, rot-proof and easy to use, NIVO pedestals comply with demanding regulations.

They ensure stability, aesthetics and durability for your deck.

NIVO





PRECISE ROBUST PRACTICAL

- 1000 kg compression load
- 100% recycled polymer
- Weather and UV resistance
- 60 mm extension to raise up to 530 mm
- Factory pre-assembled
- Thermo-wrapped 10-pieces packs





NIVO PEDESTALS



NIVO PEDESTALS



STRUCTURAL ALUMINIUM JOIST

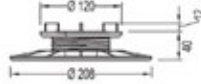

H 25 - 40 mm
FD2120

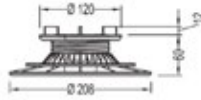

H 40 - 60 mm
FD2121

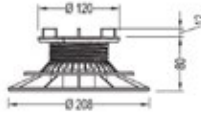

H 50 - 80 mm
FD2122

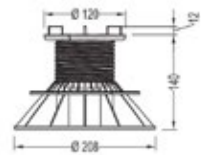

H 80 - 140 mm
FD2123

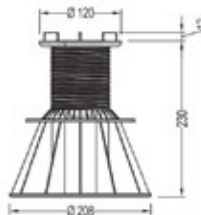

H 140 - 230 mm
FD2124



WOODEN JOISTS

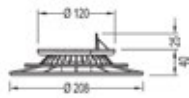

H 25 - 40 mm
FD0113

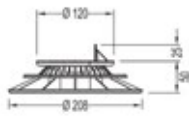

H 40 - 60 mm
FD0109

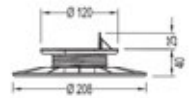

H 50 - 80 mm
FD0110

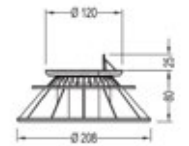

H 80 - 140 mm
FD0111

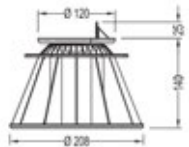

H 140 - 230 mm
FD0112

CERAMIC PAVING

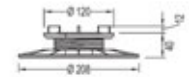

H 25 - 40 mm
FD0337

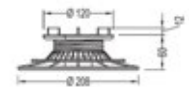

H 40 - 60 mm
FD0273

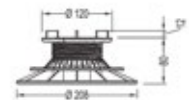

H 50 - 80 mm
FD0274

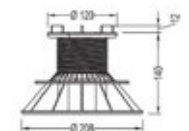

H 80 - 140 mm
FD0275

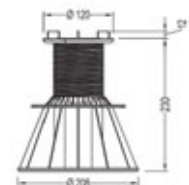

H 140 - 230 mm
FD0276

NIVO PEDESTALS



1

CUSHIONING PAD FD0898

Provides soundproofing and comfort under paving. 5 mm thick

2

60 MM EXTENSION FD0206

Stackable up to a maximum of 5 to reach 530 mm height

3

SLOPE CORRECTOR FD0338

Combination of 2 discs for slope correction from 2 to 5%

SPIRAL

FOUNDATION SCREW



A PRACTICAL & ECOLOGICAL FOUNDATION SOLUTION

The SPIRAL foundation screw is a galvanized steel pile with a threaded design that allows it to be driven and securely anchored into the ground. It enables the installation of a perfectly stable and leveled wooden or aluminum structure capable of supporting heavy loads.

The installation is simplified thanks to the adjustment possibilities and the ability to correct imperfections. The foundation screw is suitable for various installations: decking, pools, hot tubs, carports, shelters, etc.

Available in multiple sizes and for different uses, it meets the need to correct steep slopes, elevate structures, or create different levels without complicating the construction.

This solution is a perfect alternative to creating a concrete slab. It offers less expensive, faster foundation work, better preservation of the garden, and improved soil drainage. The type of screw to use depends on the nature of the soil.





SPIRAL





FAST RESISTANT POLYVALENT

- High compressive loads
- Pull-out resistance
- Durable - Galvanized steel
- Penetrating tip
- No concrete slab
- Removable



SPIRAL



My **Deck
Planner**
by Felix

G-800



FD1577

80 CM

G-1200



FD1578

120 CM

G-1500



FD1806

150 CM

Firm soils & Backfill



SPIRAL

S-1200



120 CM

Sand & Soft Soils

FD1807

P-800



80 CM

Posts
(excluding fencing)

FD1808

CERTIFICATS

Manufacturing process **ISO 9001:2015**

Product **EN 1090**

Material **ISO 630 FE 360A**

Galvanization **EN 1461**

Reinforced galvanized steel **Z600**

Average thickness 70um, min 55um

Expected service life **50 years***



Environmental performance **ISO 14001**

* Under normal conditions of exposure





COBRA
GLOBAL DECKING SYSTEM

ACCESSORIES

Spiral



1



2



3



4



5



1	LEVELLING DISC		FD1904
2	JOIST STRADDLE FOR HIGHER JOIST WEDGING		FD2092
3	ADJUSTABLE JOIST SUPPORT		FD1809
4	U-SHAPE POST SUPPORT CENTRAL MOUNTING SCREW M16X50 AND WASHERS INCLUDED	90X90MM 120X120MM	FD1901 FD1902
5	FLAT MULTI-USE SUPPORT 90X90MM		FD1221

ACCESSORIES

Spiral



BOLTING ADAPTATOR

- Ensures connection between tool and foundation screw
- Central mounting for quick, easy and firm assembly
- 6 peripheral lugs
- Integrated bubble level
- M41 hexagonal center head
- Compatible with Milwaukee M18FHIWF1-122 or Makita TW1000 impact bolters

FD0616

MANUAL SCREWING TOOL

- Kit includes pre-drilled mast for bar height adjustment
- 160 cm wingspan
- 3 bolts + nuts to secure tool to screw
- The bar is adjustable during screwing to facilitate pushing

FD0615





HYBRID

DECKING CLIPS



3 TYPES / 3 SIZES

HYBRID is a unique and innovative invisible fastening system, the fruit of many years' experience in decking design.

Its dual-material conception provides exclusive technical features and performance that guarantee perfect hold and impeccable stability over time.

What's more, the clip's unique pre-installed screw makes it easy and quick to install.

The HYBRID range adapts and meets every need, with three sizes to choose from. A clip for every deck. A screw for every joist.

JOIST TYPES

Aluminum Softwood Hardwood



HYBRID

8-18

Composite boards

S

M

L



HYBRID

7-22

Bamboo boards

S

M

L



HYBRID

8-25

Hardwood boards

L

L

L



S

M

L

HYBRID clips are available in 3 screw sizes for optimum fastening of a wide range of compatible decking boards*.

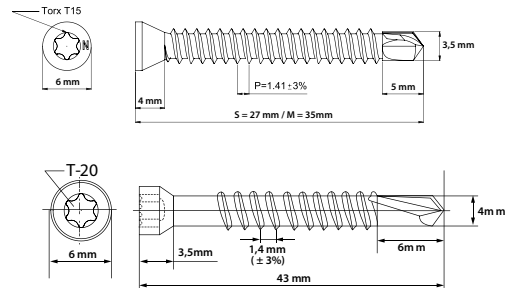

* For installation at outdoor temperatures below 5°C, we recommend to lubricate the fixing point and to adjust the drilling torque.

** Compatible deck board dimensions detailed on p. 43-47.



FAST **RELIABLE** **INNOVATIVE**

- **High pull-out strength**
- **Absorbs deck movements**
- **Quick and easy assembly**
- **Mounting on wood & aluminum joists**
- **Local dismantling possible**
- **Compatible with reversible boards**



HYBRID CLIPS

My Deck Planner
by Felix



COBRA GLOBAL DECKING SYSTEM
FASTENER®

Factory-fitted stainless steel screws on the clip for quick and easy installation. Torx print for ease of use and precision

30 mm wide, 1.20 mm thick, AISI 304 stainless steel wing for optimum support, mat black lacquered, anti- glare

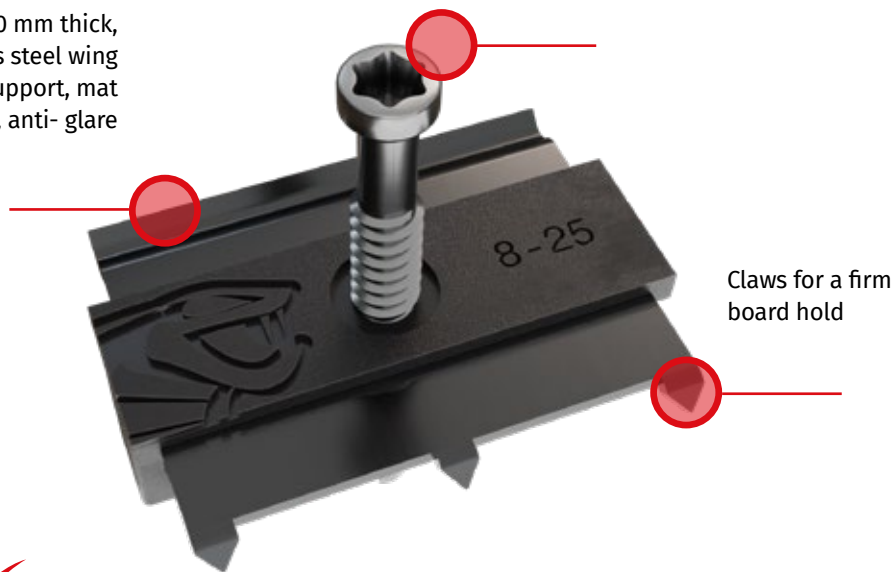

Claws for a firm board hold



BREVETÉ
22 160 820.1



Honeycomb structure absorbs deck board movements

Black, UV resistant polypropylene body, 6 mm wide to ensure even spacing between boards

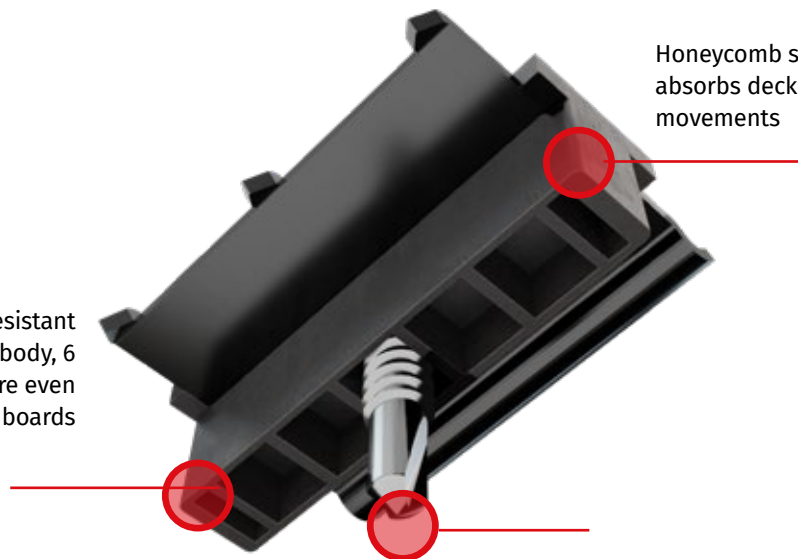

Self-drilling point for fixing in wood or aluminium



HYBRID CLIPS

HYBRID CLIPS





HYBRID 8-25

For hardwood

8-25L
FD0964

- Highly durable screw : 4.8 mm diameter
- Screw length of 43 mm: excellent grip in wooden joists
- Honeycombed clip body: absorbs board swelling
- Asymmetric stainless steel wing: One side with claws grips and holds the board, while the other side is curved to flatten the board and allow wood expansion
- Box of 90 clips: covers an area of 4-5 m² of decking surface
- Drilling capacity in aluminium: 4 mm

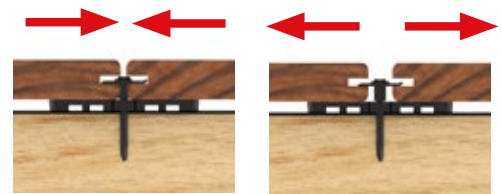
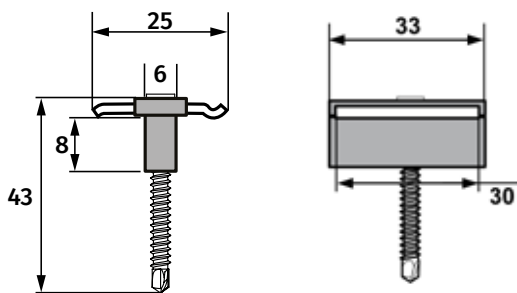
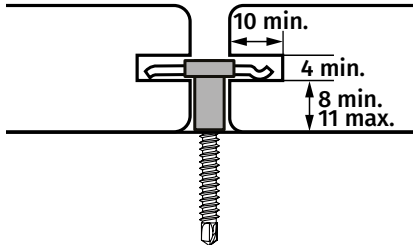

AIR SPACER use recommended
See p.48



HYBRID 7-22

For bamboo

7-22 S	FD2016
7-22 M	FD1334
7-22 L	FD1988

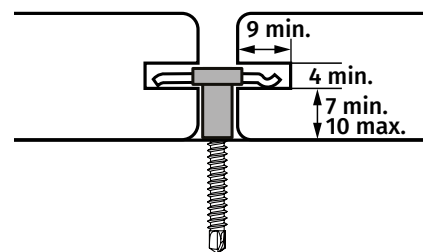

SIZES S AND M

Screw 4.2 x 27 mm in size S
For aluminum joists

4.2 x 35 mm screws in size M
For aluminum or softwood joists

- Borrow Torx TX15
- Drilling capacity in aluminium: 3 mm
- Drilling in wood up to 800 kg/m³ density
- Reduced head diameter 6 mm, black lacquered

SIZE L

Screw 4.8 x 43 mm
For aluminum or hardwood joists

- Borrow Torx TX20
- Drilling capacity in aluminium: 4 mm
- Drilling in wood up to 900 kg/m³ density
- Reduced head diameter 6 mm, black lacquered

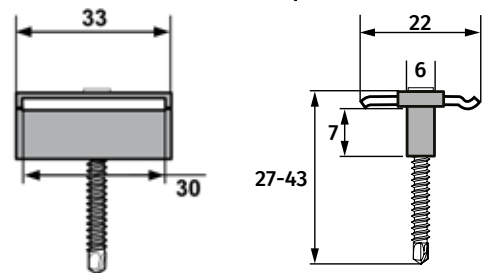

AIR SPACER use recommended
 See p.48

HYBRID CLIPS



HYBRID CLIPS

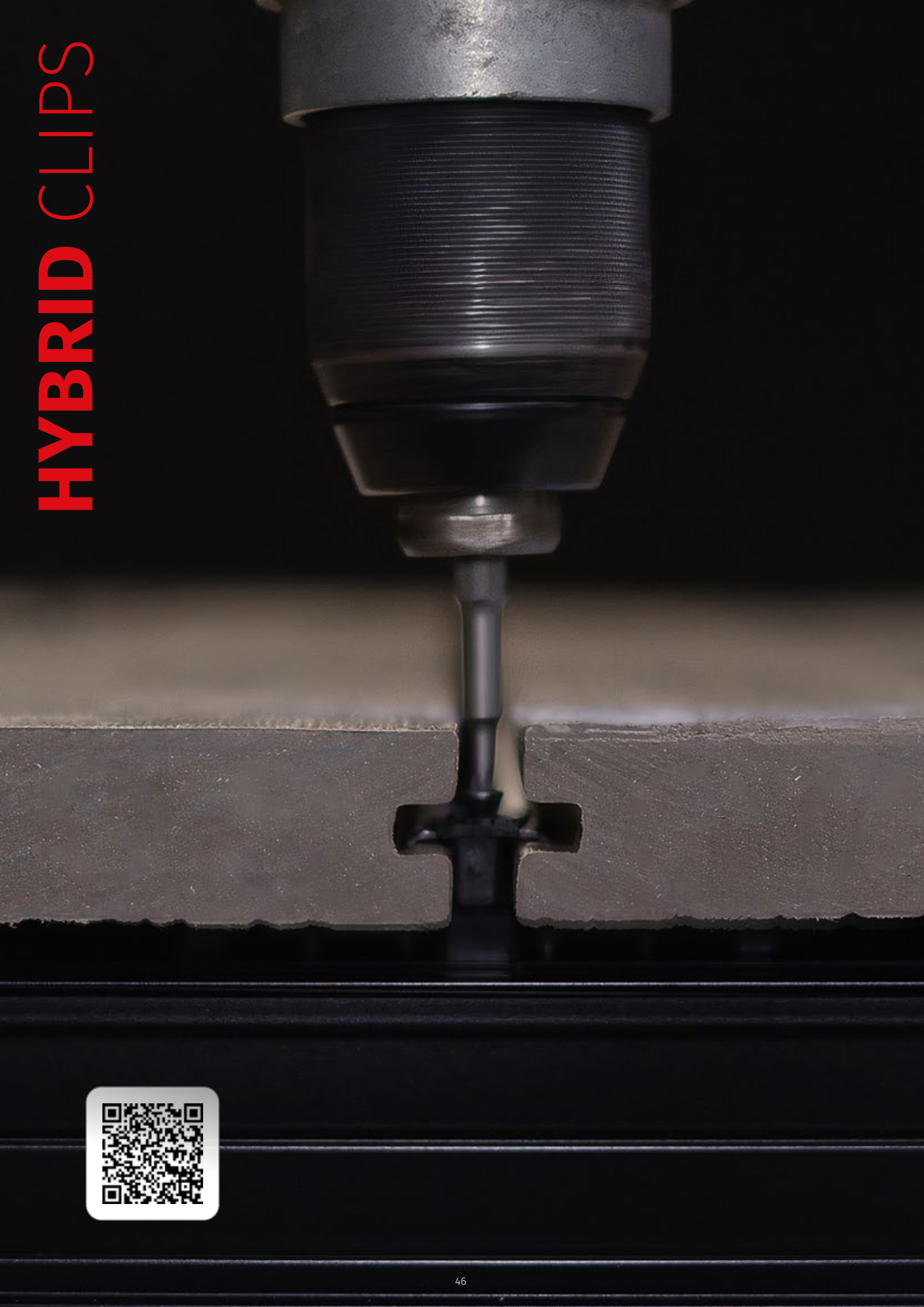



HYBRID 8-18

For composite wood



8-18 S	FD1989
8-18 M	FD0993
8-18 L	FD1987

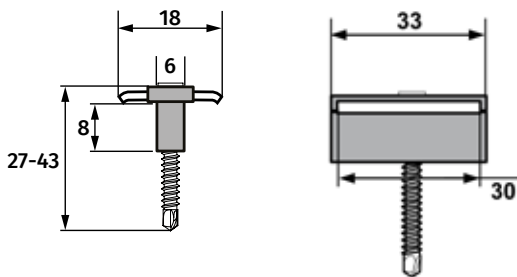
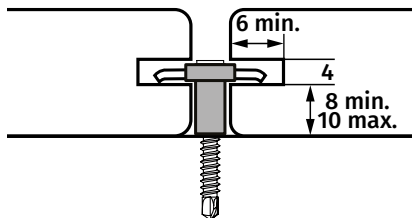

SIZES S ET M

4,2 x 27 mm in size S
For aluminum joists

Screw 4,2 x 35 mm in size M
For aluminum or softwood joists

- Borrow Torx TX15
- Drilling capacity in aluminium: 3 mm
- Drilling in wood up to 800 kg/m³ density
- Reduced head diameter 6 mm, black lacquered

SIZE L

Screw 4,8 x 43 mm
For aluminum or hardwood joists

- Borrow Torx TX20
- Drilling capacity in aluminium: 4 mm
- Drilling in wood up to 900 kg/m³ density
- Reduced head diameter 6 mm, black lacquered



AIR SPACER Use recommended
 See p.48

AIR SPACER

Ventilation wedge

- Makes Hybrid use easier and faster
- Provides ventilation between boards and joists
- Extends deck life
- 4 board spacers 3 / 4 / 5 / 6 mm supplied
- Recycled polyamide, UV, heat and frost resistant
- Complies with the requirements of DTU 51.4
- Compatible and recommended with all HYBRID clips

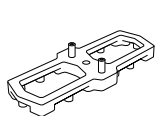

x 100

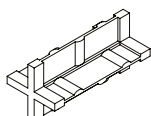

x 4



Box contents

- 100 AIRSPACER®
- 4 DECKSPACER® board spacers

FD1040



The Airspacer promotes ventilation between the board and the joist without affecting the action of the fastener or the movement of the wood. Its design allows perfect assembly with Cobra Hybrid clips for fast, easy installation.



AIR SPACER



COBRA HARDWARE





STAINLESS STEEL WOOD/ALUMINUM SCREWS A4 self-drilling

- AISI316 stainless steel screws: suitable for salty environments
- Pre-drilling of decking required
- Self-drilling point for aluminium structures up to 3 mm thick
- Narrow, stepped screw head to reduce wood splintering
- Low-profile, perfectly recessed head for optimal pressing
- Suitable for fastening finishing skirtings

FD2110 5.5x45mm (200pcs)
 FD2126 5.5x45mm (100pcs) Grey
 FD2127 5.5x45mm (100pcs) Brown

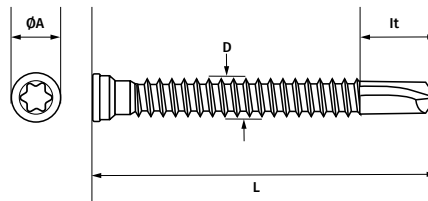

Size	A (mm)	L (mm)	D (mm)	It (mm)	Torx
M5.5 x 45	7,9 - 8	45	5,5	9,5	T20

FINISHING & SCREWS

Decking

COBRA START/END

Two in One



- AISI304 stainless steel clip (30 pcs)
- AISI304 stainless steel screws 4.5x25 mm (30 pcs)
- Pre-drilling required
- Anti-glare matte black color
- 2 possible screwing options

FD0336

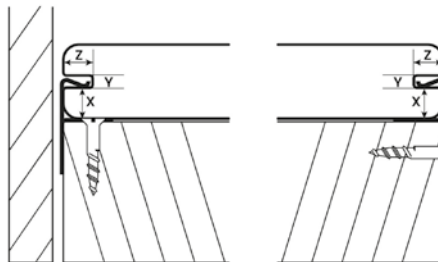

X	Y	Z
8 mm	4 mm	10 mm



COBRA END

Adjustable

- AISI304 stainless steel clip (30 pcs)
- AISI304 stainless steel screws 4.5x25 mm (30 pcs)
- Pre-drilling required
- Anti-glare matte black color
- Adapts to all board heights

FD1432

X	Y	Z
All sizes	4 mm	8 mm

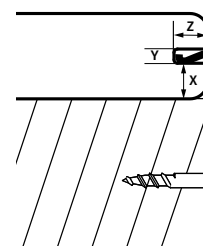



FD0770-0729

FD0771-0728

SELF-DRILLING A2 STAINLESS STEEL SCREW

Composite decking

- AISI304 stainless steel screws
- Cutting thread for better penetration into composite wood
- Reduced head
- Double-threaded to prevent material build-up
- Blade-matched colors for a flawless finish
- Pre-drilling required
- Compatible with all brands of solid-core wood composite boards
- Suitable for fastening finishing skirtings

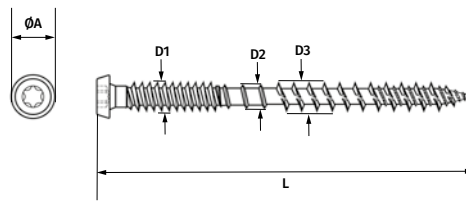

Skus	Size	A (mm)	L (mm)	D1 (mm)	D2 (mm)	D3 (mm)	Torx
0770 - 0771	M5 x 50	7,5 - 8	50	5,2-4,9	4,0-4,3	4,9-5,2	T20
0728 - 0729	M5 x 63		63				



SELF-DRILLING A2 STAINLESS STEEL SCREW

Wood decking

- AISI304 stainless steel screws
- Cutting thread for better wood penetration
- Tapered tip to reduce wood splitting
- Moleton to facilitate screw drilling in wood
- Pre-drilling required
- Deep Torx to prevent rejection and shifting of the bit

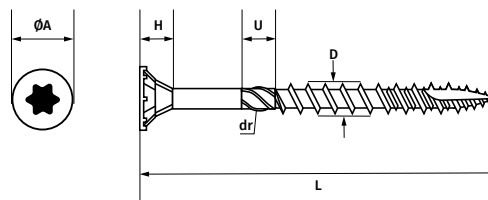

Skus	A (mm)	L (mm)	U (mm)	D (mm)	dr (mm)	Torx
0601	8	50	4	5	4	T25
0602	8	60	8	5	4	T25
0613	10	70	10	6	5	T30

D-LOCK

Universal clip

- Invisible fastening
- Universal clip for deck boards 20 to 28 mm thick and 90 to 150 mm wide
- Fastening system for non-grooved deck boards
- Ensures ventilation under the blade
- Robust and resistant to humidity and extreme temperatures
- Made of POM polymer material: polyoxymethylene
- Compatible with all wooden decking and structures, with pre-drilling required



INTERMEDIATE CLIP



START/END CLIP

FD0600

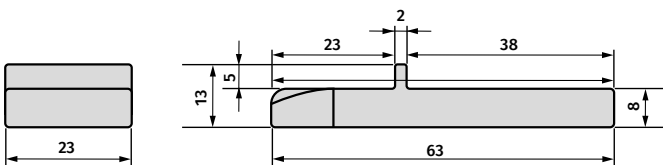

BOX CONTENTS

- 110 Clips size: 23x60x8 mm
- 15 Start/End clips
- 250 stainless steel screws: 4x25 mm
- 55 stainless steel screws: 4x40 mm
- 1 Metal drilling template
- 4 spacer clips: DECKSPACER®

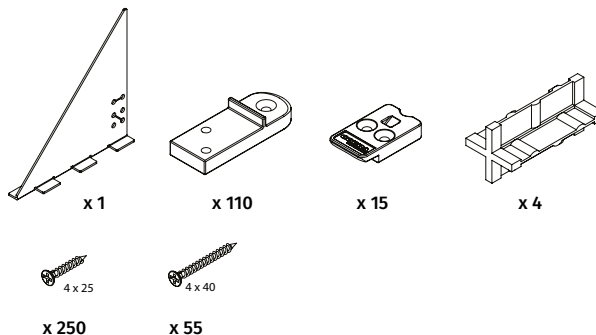

D-LOCK CLIP

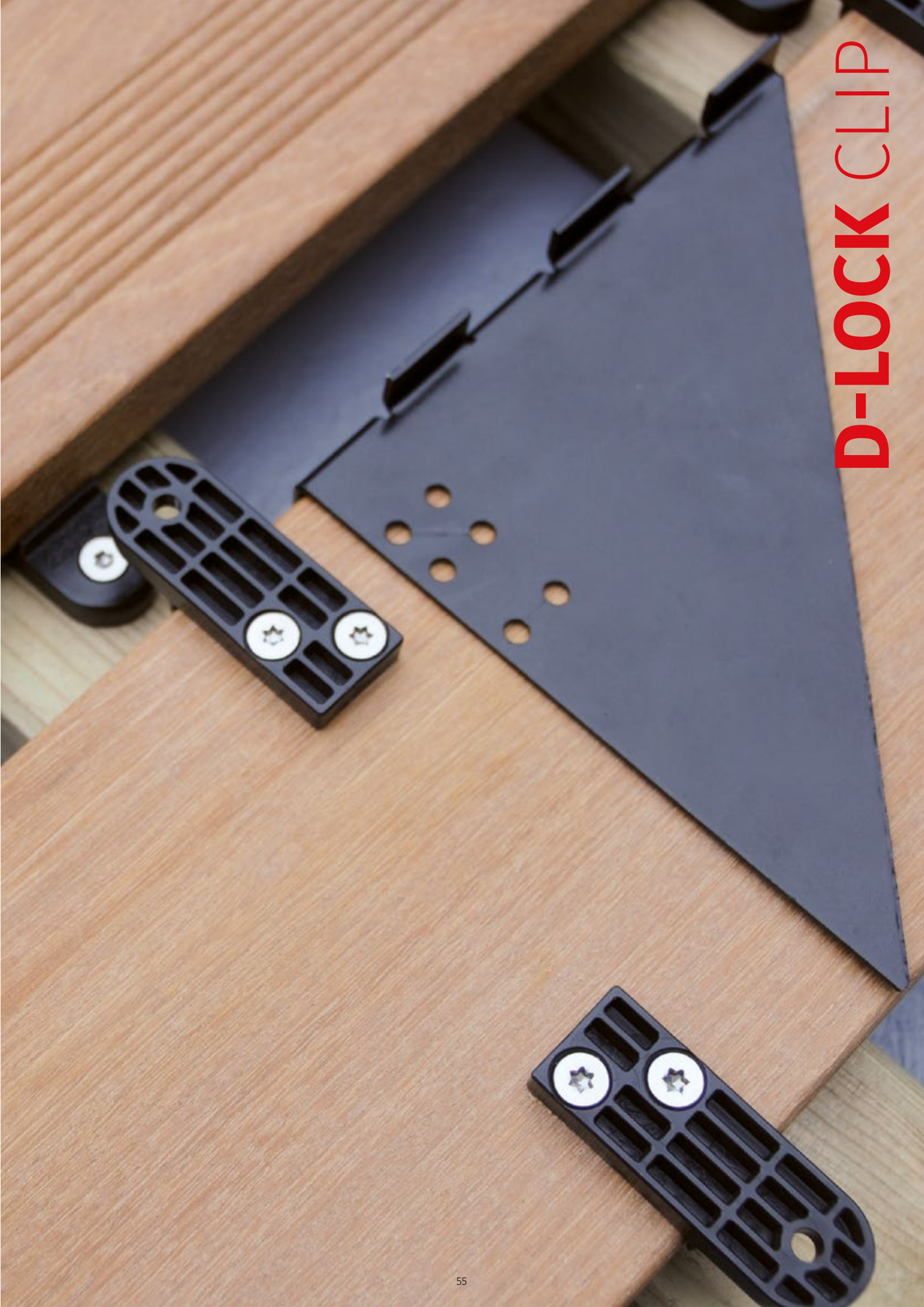

ACCESSORIES

DECKING



ESSENTIAL & FUNCTIONAL

There's more to building a durable deck than just the boards, their fastenings and the structure.

To ensure rigorous, compliant construction, installation accessories are functional elements that provide efficiency, ease of use and precision.

Cobra range essentials such as sealing tape, various wedges and drilling aids guarantee the longevity and aesthetics of your project.



BITUDECK

Sealing strip

- Extends the life of wooden joists
- Complies with the high level requirements
- Waterproof - Absorbs sound resonance
- Matte black to avoid light reflections between the boards
- Resists tearing, warping and temperature variations
- Easy and convenient to use

FD0145

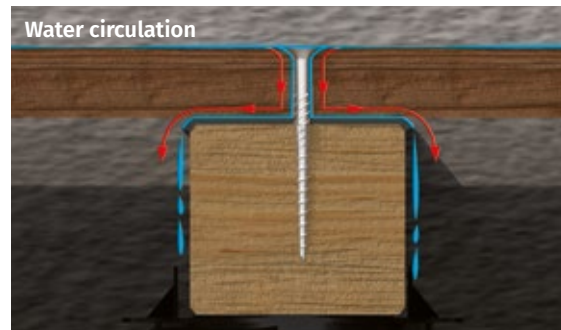

BITUDECK adhesive waterproofing tape considerably extends the life of your wooden structure by effectively protecting it from moisture.



100 GR/M² GEOTEXTILE

Practical & easy

- Polypropylene
- Opaque black
- Prevents weeds from growing back
- Rot-proof
- Resistant
- Simply laid on the ground
- Water permeable, promotes drainage

FD0607

PROPERTIES

Weight	Thickness	Resistance tearing*
100 g/m ²	0.55 mm	0.413 kN *ISO 12236 : 2006 **ISO 10319 : 2015
Traction in width**	Elongation at maximum tensile load	
13.6 kN/m	132%	





INSTALLATION AIDS

Decking



COBRA LINER

Drilling template

- Ensures perfect alignment of screws when screwing in deck boards
- Ensures screws are set back 20 mm from the edge of the boards, in accordance with most requirements
- Adjustable for all deck board widths
- Time-saving, easy to use
- Supplied with 4 DECK SPACERS

FD0603

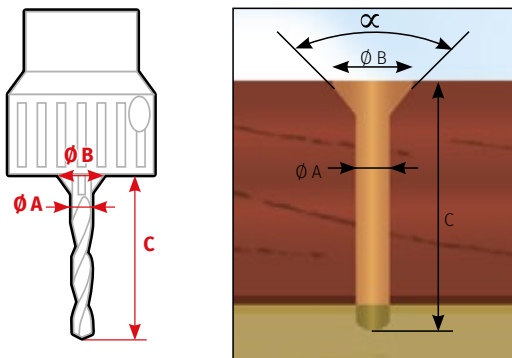

COBRA® SMART BIT

Pre-drilling

- 2-in-1 tool: drills and mills the deck board, for an impeccable finish
- Stop on anti-tracking bearing with rubber buffer ring
- 3 interchangeable Powerbolic® HSS steel drill bits included
- Chip cavity

Designation	ØA (mm)	ØB (mm)	C (mm)	α (°)
#8 - 4.5	3,2	6,6	30	60
#10 - 5.0	3,6	9,2	30	90
#12 - 6.0	4,0	11	40	82

Cobra Smart-bit #8 - 4.5	FD0214
Cobra Smart-bit #10 - 5.0	FD0215
Cobra Smart-bit #12 - 6.0	FD0218

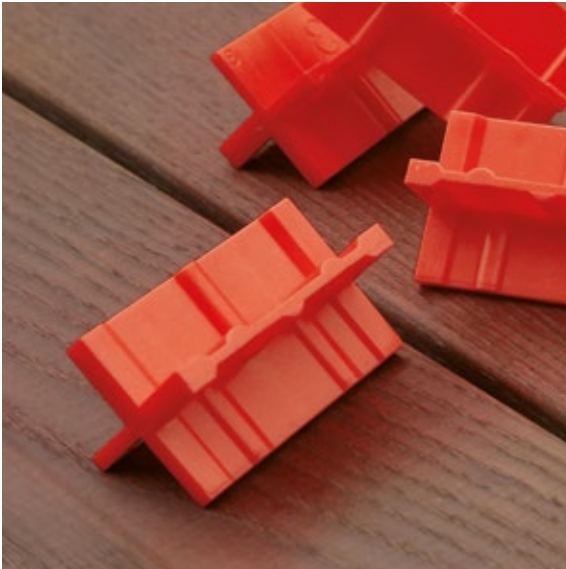

DECK SPACER

Regular joints

- Ensures regular spacing between the boards for wood expansion and contraction, in compliance with the DTU 51.4 standards.
- Guarantees linear expansion gaps at the ends of composite wood boards.
- 4 wings with 4 different spacing options.

FD0604

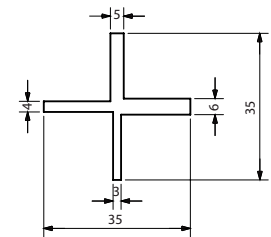

COBRA WRENCH

Board straightener

- For straightening warped deck boards
- Easy to use, for right- or left-handed users
- Lightweight, ergonomic tool
- Supplied with lugs of various sizes, adjustable to joist dimensions

FD0216

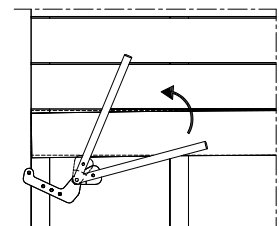

WEDGES

Decking



Thickness 2 mm



Thickness 3 mm



Thickness 4 mm



Thickness 5 mm



FLATPAD

- Fast, precise levelling
- Corrects thicknesses from 2 to 5 mm
- Rot-proof, strong and UV-resistant

FD0135



RUBBERPAD

- Extends the life of your structure
- Allows rainwater to circulate under the joist
- Protects joists from ground moisture
- Rot-proof
- Shore hardness: 55A
- Density: 730 kg/m³

8x90x90 mm (24 pcs)	FD0210
8x60x90 mm (48 pcs)	FD0608
3x60x90 mm (60 pcs)	FD0609



WEDGEPAD

- Corrects thicknesses from 10 to 30 mm
- Thoothed – can be combined with one another
- Rot-proof, sturdy and UV-resistant
- Can be screwed or glued in place

FD0610

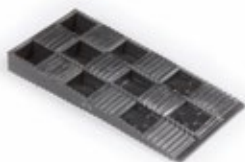

Thickness 10-15 mm



Thickness 5-20 mm



Thickness 20-30 mm

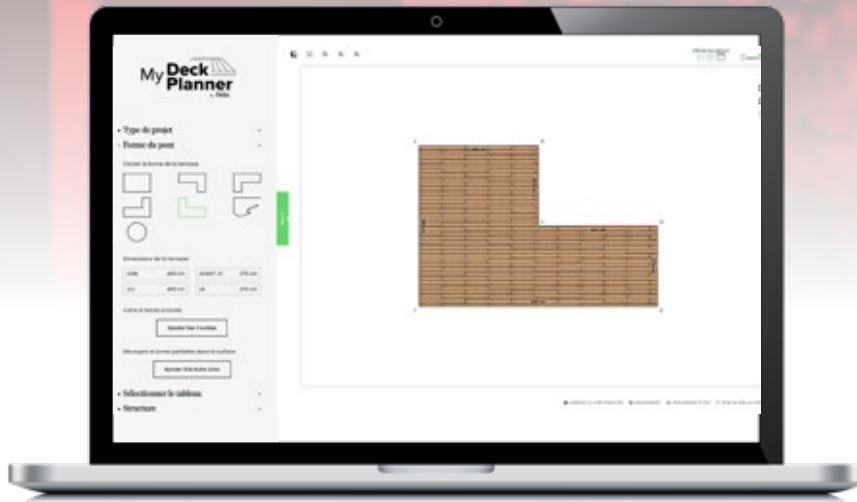

BUILD YOUR DECKING PROJECT WITH EASE

A free online software that simplifies your decking project.
Design, configure, calculate and visualize your deck with a customized
plan and a precise list of materials.

A practical solution for a perfect result !

en.mydeckplanner.com

**My Deck
Planner**
by Felix





cobrafastener.com